

E7CBG02

CUCINA A 2 FUOCHI GAS SU MOBILE APERTO

2 BURNERS GAS RANGE ON OPEN-FRONTED UNIT



Caratteristiche
Features

Piano di lavoro in acciaio inox AISI 304 | Griglie del piano in ghisa vetrificata | Bacinelle raccogliogocce del piano estraibili in acciaio inox AISI 304 stampate ad angoli arrotondati | Bruciatori in ghisa vetrificata con spartifiamma in ottone a fiamma stabilizzata (2 x 10 kW) | Rubinetti valvolati con fiamma pilota per l'accensione del bruciatore | Pannello comandi facilmente estraibile per facilitare le operazioni di pulizia e manutenzione | Piedini in acciaio inox regolabili in altezza

Work top in AISI 304 stainless steel | Top grids are in vitrified cast iron | Removable drip-collecting trays in AISI 304 stainless steel with rounded corners | Burners in cast iron with burner cap in brass and stabilized flame (2 x 10 kW) | Valve tap with pilot flame for gas burner ignition | Control panel which can be quickly removed for easy cleaning and maintenance | Adjustable AISI 304 stainless steel feet



MODELLO
MODEL



DIMENSIONI mm
DIMENSIONS mm



POTENZA GAS KW
GAS POWER KW



VOLUME m³



PESO Kg
WEIGHT Kg



ALLACCIAMENTO GAS
GAS CONNECTION

E7CBG02

400x730x900

20

0,5

50

Ø 1/2"

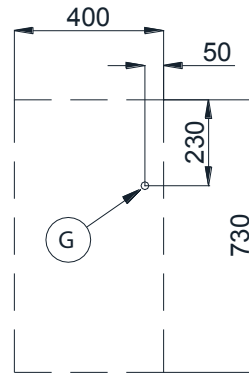
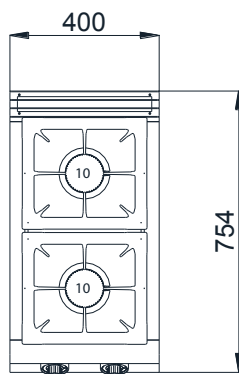
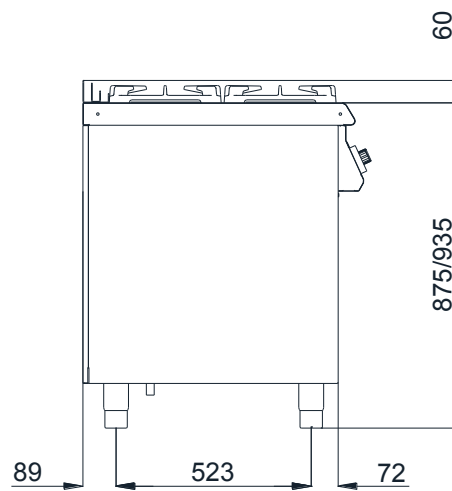
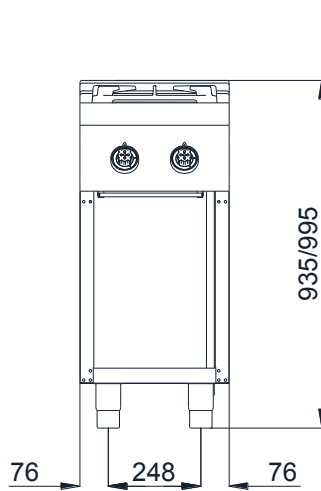

G = Gas Ø 1/2"