













Alle Modelle: EW21 - EW24 - EW36 - EW41 - EW52 - EW72 - EW89

**Technische Daten - Spezifikationen**

											
	cond	comp. W	ABS. W	Fuse	Kwh/100Kg	l/h	kg	Lbs	kg	Lbs	Ton CO2 equiv.
<b>EW36 A</b>		755	470	10	32.6	2.58	36	79	44	97	0,329
<b>EW36 W</b>		755	470	10	25.1	31.2	36	79	44	97	0.286



**EISWÜRFEL Tagesproduktion**

Abhängig von der Lufttemperatur und von der Temperatur des zugeführten Wassers

**Luftgekühlte Version**

Lufttemp.	Wassertemperatur			
	32°	21°	15°	10°
°C	32°	21°	15°	10°
°F	90°	70°	60°	50°
10°	<b>29</b>	<b>32</b>	<b>34</b>	<b>36</b>
50°	64	71	75	79
21°	<b>27</b>	<b>30</b>	<b>32</b>	<b>34</b>
70°	60	66	71	75
32°	<b>22</b>	<b>24</b>	<b>26</b>	<b>28</b>
90°	49	53	57	62
38°	<b>19</b>	<b>21</b>	<b>22</b>	<b>23</b>
100°	42	46	49	51

**Wassergekühlte Version**

Lufttemp.	Wassertemperatur			
	32°	21°	15°	10°
°C	32°	21°	15°	10°
°F	90°	70°	60°	50°
10°	<b>28</b>	<b>32</b>	<b>34</b>	<b>36</b>
50°	62	71	75	79
21°	<b>26</b>	<b>30</b>	<b>32</b>	<b>34</b>
70°	57	66	71	75
32°	<b>25</b>	<b>29</b>	<b>31</b>	<b>33</b>
90°	55	64	68	73
38°	<b>21</b>	<b>26</b>	<b>28</b>	<b>29</b>
100°	46	57	62	64

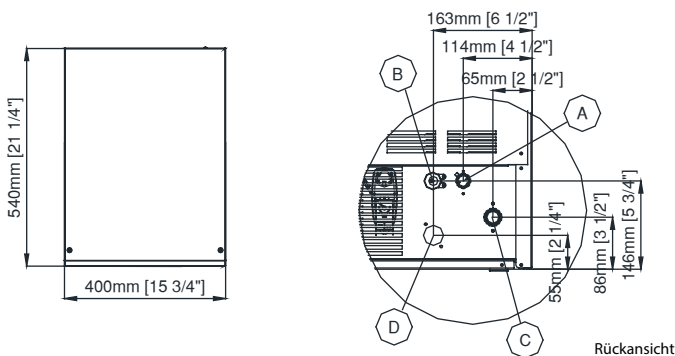
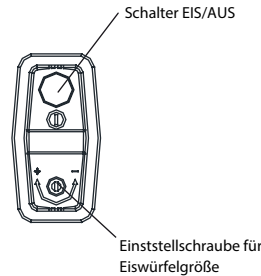
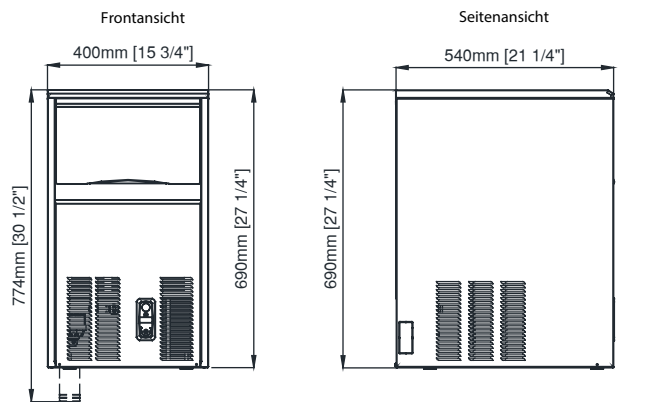

- (A) Elektrische Kabelführung
- (B) Tauwasserablauf - Ø 20 mm
- (C) Frischwasseranschluss - 3/4" gas
- (D) Kühlwasserabfluss - Ø 20 mm



**Zusatzausstattung:**  
4 höhenverstellbare FüÙe  
Ø50mm H100-120 mm



**BEDIENFELD**



**KAPAZITÄT VORRATSBEHÄLTER**

11.5 kg - 25.3 lbs / 575 Stück

**ABMESSUNGEN**

BxTxH (mm): 400 x 540 x 690



**VERPACKUNGSDATEN**

BxTxH (mm): 460 x 600 x 850

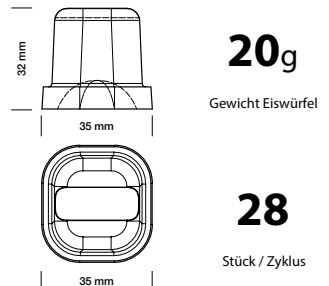
**EISWÜRFEL TYP**



**BETRIEBSBEDINGUNGEN**

	
220-240V / 50Hz / 1	R134a GWP=1430
<b>MIN</b>	<b>MAX</b>
10°C (50°F)	40°C (104°F)
5°C (41°F)	35°C (95°F)
- 10 %	+ 10 %
1 BAR (14 PSI)	5 BAR (70 PSI)

Aufgenommene Leistung **1273 W**  
Luftvolumen **185 m³/h**

**EW36 230V/1N/50Hz - Eiswürfelbereiter mit Vorratsbehälter - Sprüh System**